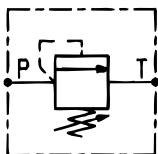

HSP

ISO
6264
4401

LIMITEURS DE BASSE PRESSION LOW PRESSURE RELIEF VALVES NIEDRIGE DRUCKBEGRENZUNGSVENTILE

Taille 3
Size 3
NG 6

Montage Mounting Einbau	Plage de pression Regulated range Druckbereich	P max Q max	Référence Part number Bestellnummer
-------------------------------	--	----------------	---

Sur embase On subplate Auf Grundplatte	2 - 50 bar	315 bar 40 l/mn	HSP	3EE	05	a	S	b
--	------------	--------------------	-----	-----	----	---	---	---

Système transfert Transfer system Transfersystem	2 - 50 bar	315 bar 40 l/mn	HSP	3ET	05	a	**	b
--	------------	--------------------	-----	-----	----	---	----	---

Fuite à 25 bar Leakage at 25 bar Leckage bei 25 bar	12,5 cm ³ /mn maxi
---	----------------------------------

a	Matière joint Seal materials Dichtungswerkstoffe
H	Nitrile (standard)
V	Viton

b	Réglage Adjustment Einstellung
Z	Vis Screw Schraube
W	Bouton Hand knob Drehknopf
T	Vis avec plombage Tamperproof screw Verplombte Schraube

- Limiteur de pression à action directe à tiroir. Accepte contre pression dans la ligne de retour au réservoir.
- Direct acting relief valve, spool type. Full tank line back pressure capability.
- Druckbegrenzungsventil direktgesteuert. Erlaubt Gegendruck in der Rückleitung zum Tank.

HSP 3EE 05...	HSP 3ET 05...	
1.2 kg	Poids Weight Gewicht	2 x 1.2 kg + 1.3 kg

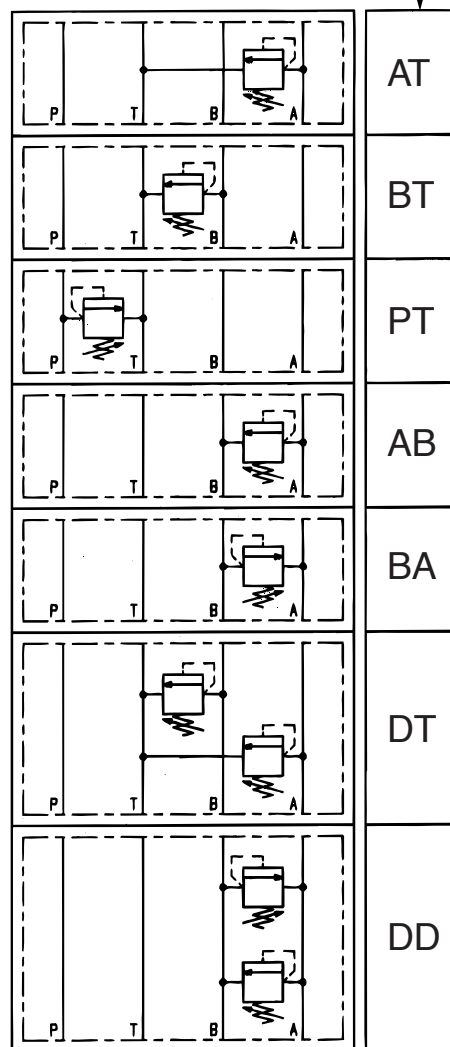

sur demande
on request
auf Anfrage

Caractéristiques Performance Kennlinien

Courbes de régulation $P = f(Q)$
Viscosité 30 cst

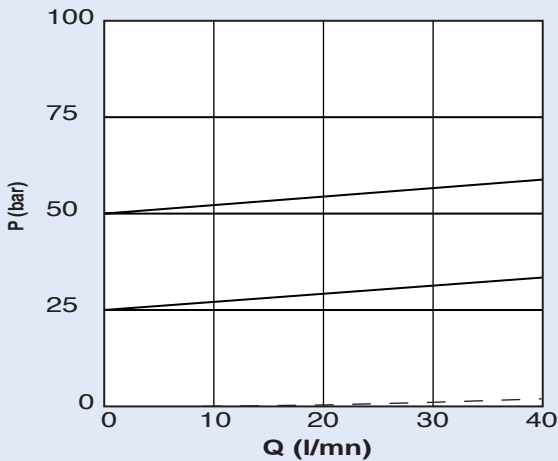

Pièces de rechange Spare parts Ersatzteile

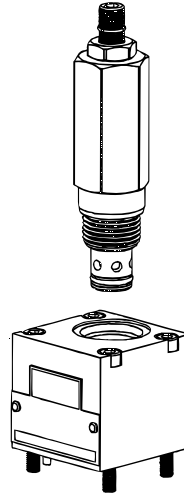

		Code
Pochette de joints (10 cartouches) Seal kit (10 cartridges) Dichtungssatz (10 Patronen)		[SK30503N]
Joints plan de pose (10 appareils) Interface seal kit (10 valves) Dichtungssatz (10 Ventile)		1591200
Cartouches Cartridges Patronen	05 - A04C2DZN (2 à 50 b)	

Encombrement Overall dimensions Abmessung

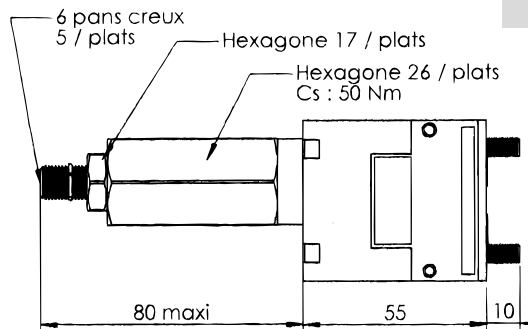
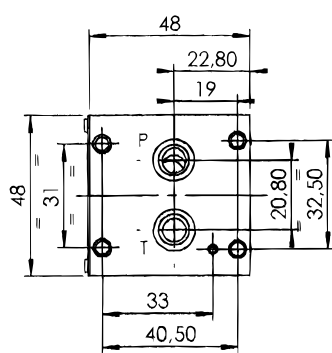

HSP 3EE05HSZ

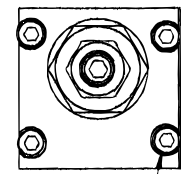

4 x CHc M5
Cs : 8.5 NM

HSP 3ET05H ** Z

