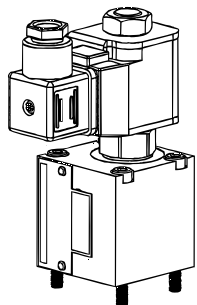

HDE

ISO
4401

DISTRIBUTEURS A CLAPET DIRECTIONAL CONTROL VALVES POPPET TYPE WEGESITZVENTILE

Taille
Size 3
NG 3

Montage Mounting Einbau	P max	Référence Part number Bestellnummer
-------------------------------	-------	---

Sur embase On subplate Auf Grundplatte	210 bar	HDE	2EE	**	a	C1	S	c
	350 bar	HDE	3EE	**	a	C1	P	c

En ligne In line Rohranschluss	210 bar	HDE	2EL	**	a	C1	S	c
	350 bar	HDE	3EL	**	a	C1	P	c

Fonction	2EE/EL	3EE/EL	
NF/NC/NL			6A
NO/NO/NO			6B
NF (2 sens)			6C
NO (2 sens)			6D

NF = normalement fermé
 NC = normally closed
 NL = normalerweise geschlossen
 NO = normalement ouvert
 NO = normally open
 NO = normalerweise geöffnet

sur demande
 on request
 auf Anfrage

Tension d'alimentation Supply voltage Versorgungsspannung	
12V CC/DC/=	C1
24V CC/DC/=	C2
48V CC/DC/=	C4
110V 50Hz	A5
220V 50Hz	A6

a	Matière joint Seal materials Dichtungswerkstoffe	b	Type de bobine Coil type Spulentyp	c	Commande manuelle de secours Manual override Hand-Notbetätigung
H	Nitrile (standard)	S	14W (210 bar)		Sans/Without/Ohne
V	Viton	P	19W (350 bar)	M	Avec/With/Mit

	210 bar		350 bar	
6A	30	30	30	40
6B	30	30	30	40
6C	40	40	40	40
6D	40	40	40	40

Ouverture/opening/Offnung
 Fermeture/closing/Schliessung

Temp.fluide/Fluid temperature/Flussigkeitstemperatur	-30<T°C<+100
Viscosité/Viscosity/Viskosität	15<cSt<50
Filtration/Filter/Filter	25 microns
Fuite interne/Internal leakage/Leckvolumenstrom 6A+6B (cc/mn)	6A 0.33 6B 0.5
Fuite interne/Internal leakage/Leckvolumenstrom 6C+6D (cc/mn)	6C 0.33 6D 0.33
Classe de protection/Protection class/Schutzklasse	IP65
Classe d'isolement/Insulation class/Isolierungsklasse	N
Poids/Weight/Gewicht	1.1 kg
Facteur de marche/Solenoid loading/Einschaltfaktor	100%

Fonction	Bobine/Coil/Spule
6A, 6C	Exitée/Under tension/Unter Spannung
6B, 6D	Au repos/No current/Ruhestellung

Perte de charge
Viscosité 30 cst

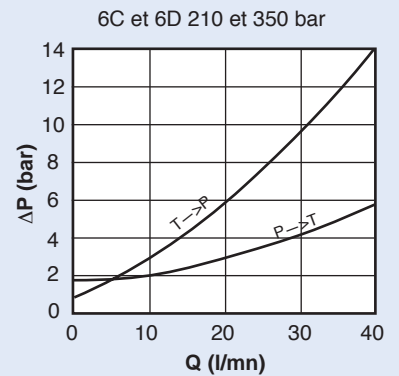
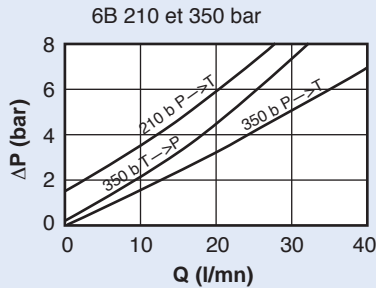
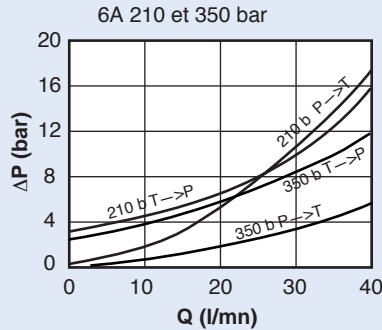

Pièces de rechange Spare parts Ersatzteile

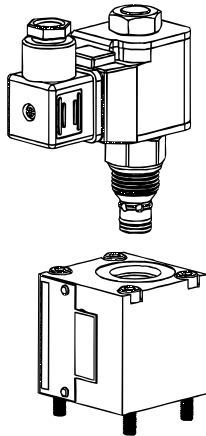

HDE *EE

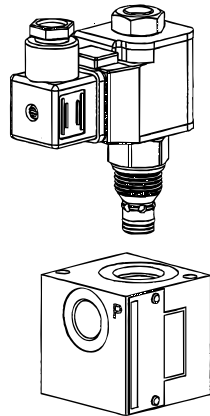

HDE *EL

Cartouches Cartridges Cartridge Ventile			Bobines Coils Spulen
210 bar	6A	GS02-01-0-0-N (1)	CCS012D
	6B	GS02-11-0-0-N (1)	CCS024D
	6C	GS02-80-0-0-N (2)	CCS115D
	6D	GS02-85-0-0-N (2)	CCS230D
350 bar	6A	GS02-08-0-0-N (1)	CCP012D
	6B	GS02-18-0-0-N (1)	CCP024D
	6C	GS02-81-0-0-N (2)	CCP115D
	6D	GS02-86-0-0-N (2)	CCP230D
Pochette de joints (10 cartouches) Seal kit (10 cartridges) Dichtungssatz (10 Patronen)			(1) SK30006N (2) SK30088N
Joints plan de pose (10 appareils) Interface seal kit (10 valves) Lochbild (10 Ventile)			Code: 1591200

Encombrement

Overall dimensions

Abmessung

HDE *EE

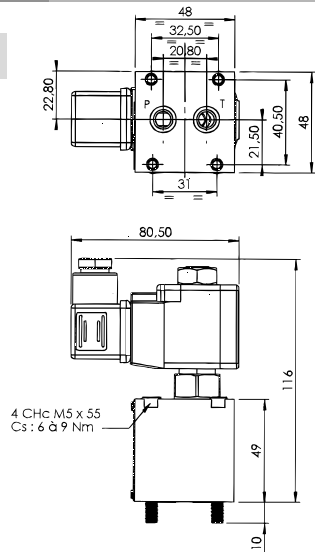

HDE *EL

Les bobines sont orientables sur 360°
The coils can be turned through 360°
Die Spulen können um 360° gedreht werden

